

CONTROLLER DATASHEET

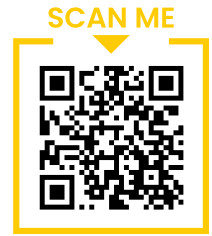

PART NUMBER: ANG-1000-CH1-5V-A1

MECHANICAL PART

2D DRAWING

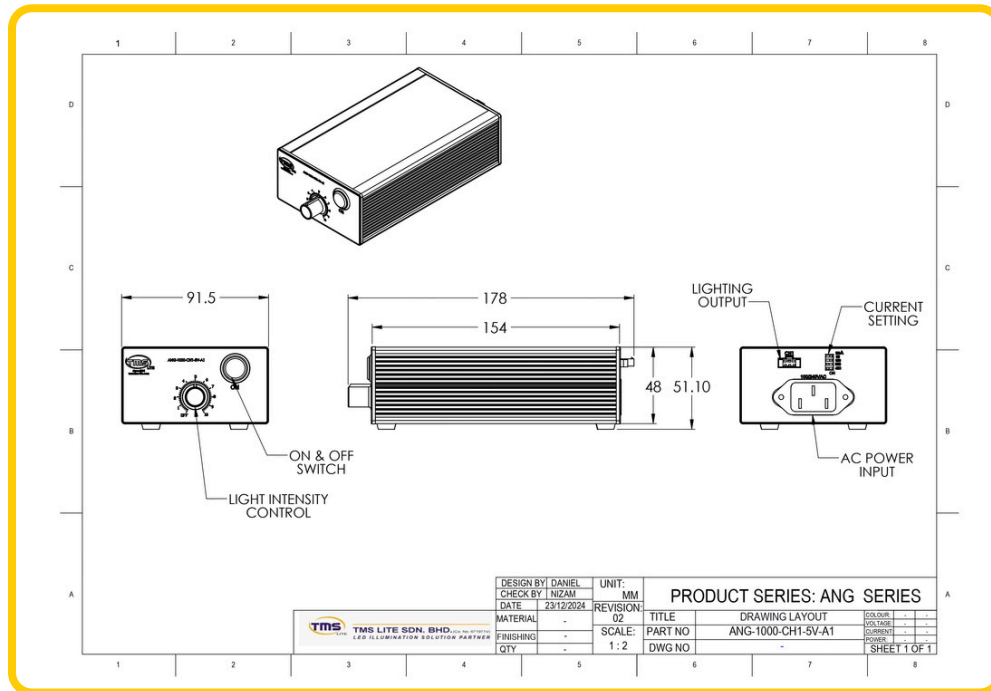

3D DRAWING

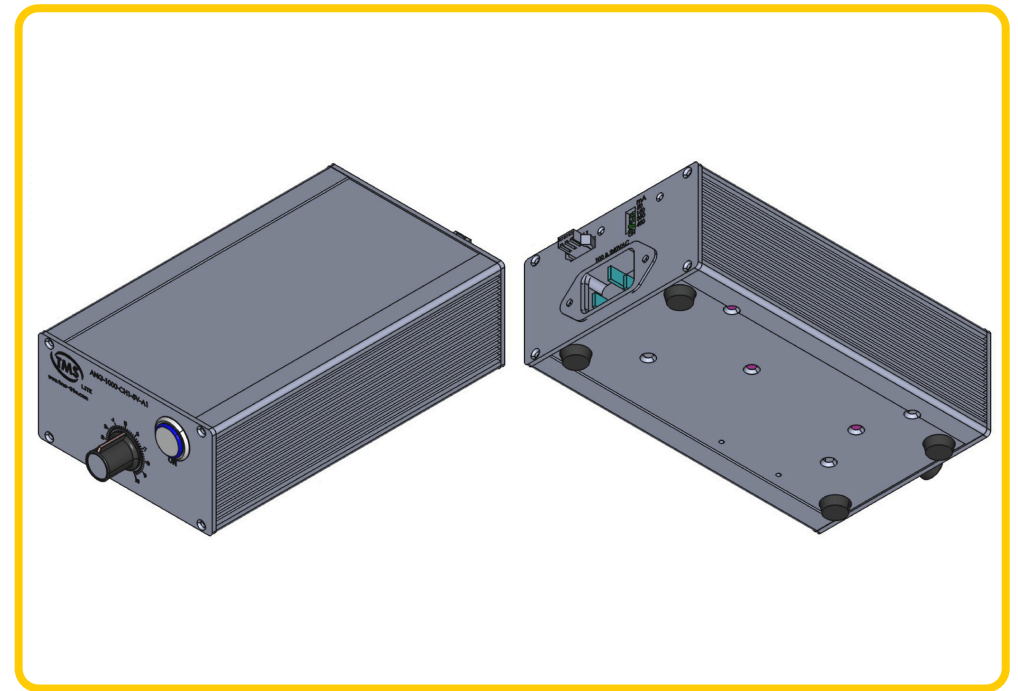

CONTROLLER DATASHEET

PART NUMBER: ANG-1000-CH1-5V-A1

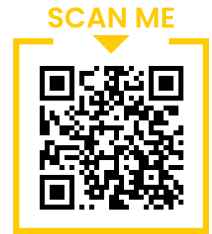

ELECTRICAL PART

SCHEMATIC DIAGRAM

N/A

TIMING DIAGRAM

N/A

CONTROLLER DATASHEET



WIRING DIAGRAM

