

CONTROLLER DATASHEET



PART NUMBER: ANG-2000-CH2-24V-A1

MECHANICAL PART

2D DRAWING

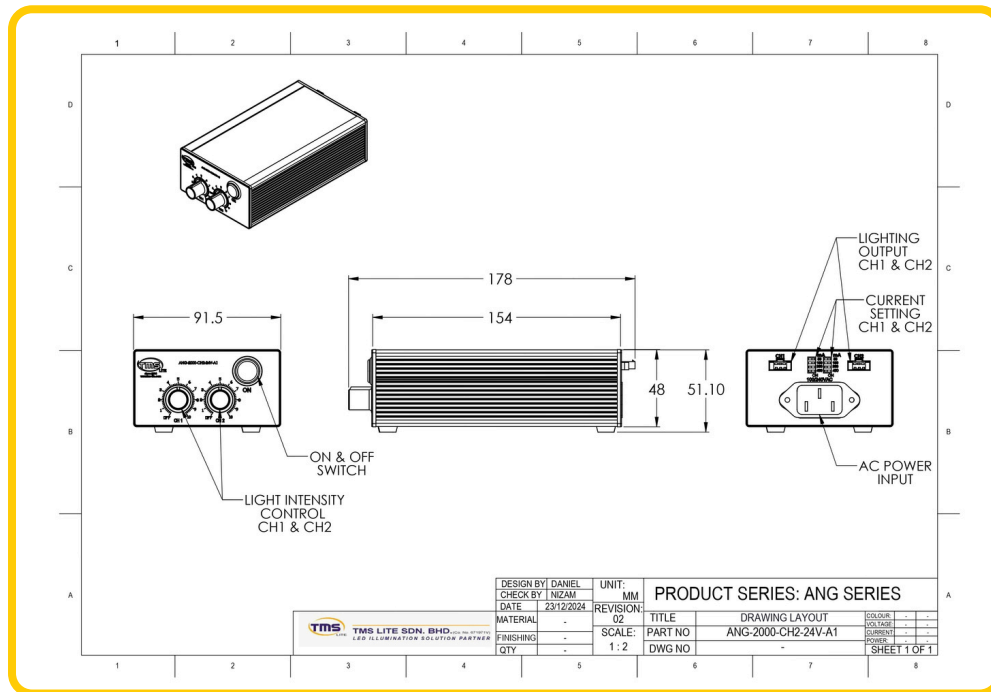

3D DRAWING

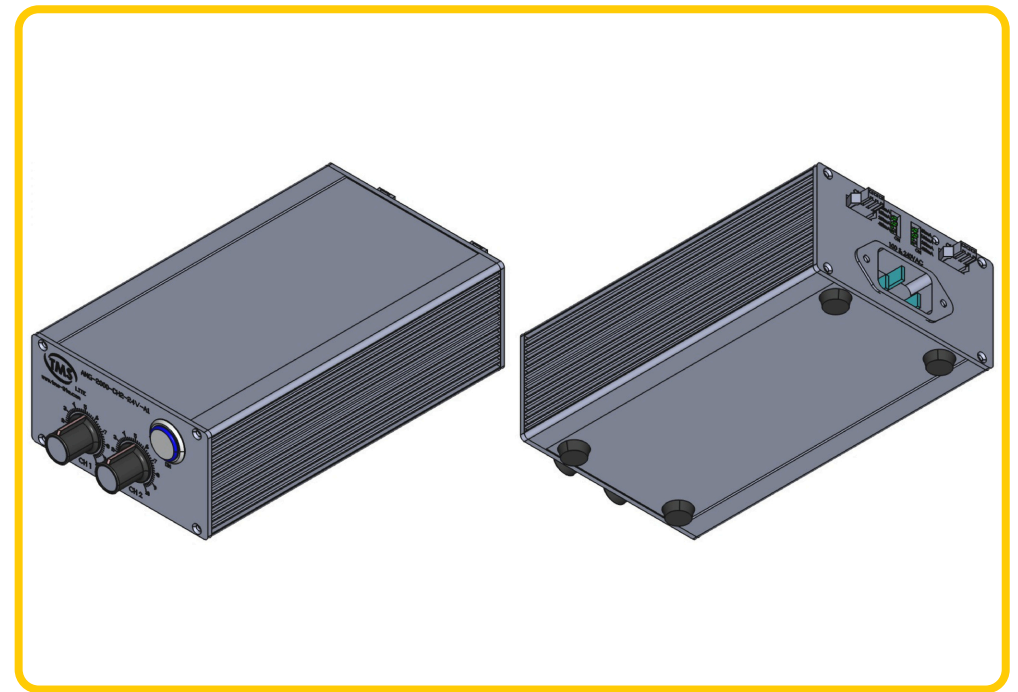

CONTROLLER DATASHEET

PART NUMBER: ANG-2000-CH2-24V-A1

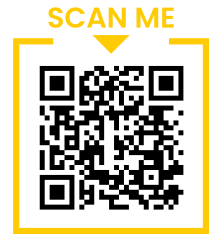

ELECTRICAL PART

SCHEMATIC DIAGRAM

N/A

TIMING DIAGRAM

N/A

CONTROLLER DATASHEET

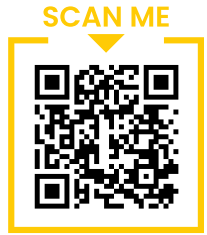

WIRING DIAGRAM

