

REVISIONS			
REV.	DESCRIPTIONS	EDIT BY	DATE:(d/m/y)

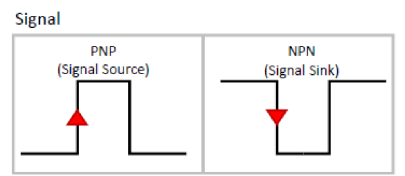

LIGHTING INPUT POWER

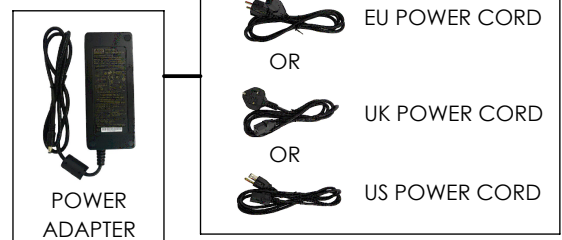

LIGHTING OUTPUT
CONSTANT & STROBE & TRIGGER:
CH1-5V / 10,000mA / 50W
CH1-12V / 10,000mA / 120W
CH1-24V / 10,000mA / 240W
CH1-48V / 10,000mA / 480W

ONE TO ONE / LOOP

*IF LIGHTING INPUT POWER SAME AS CONTROLLER INPUT POWER, IT CAN LOOP WITH SAME POWER SUPPLY



CONTROLLER INPUT POWER
12 / 24V

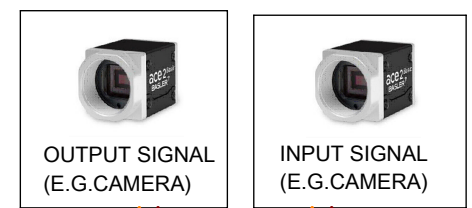
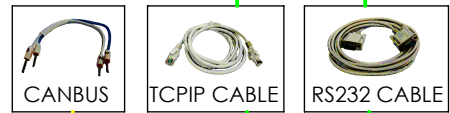

CONTROLLER INPUT
OPTIONAL

CONTROLLER OUTPUT
OPTIONAL

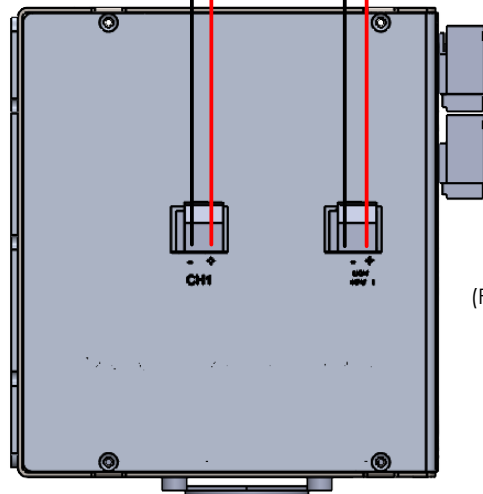

BOARD ADDRESS (FOR CASCADE PURPOSE)

LC-18-1CH-A10

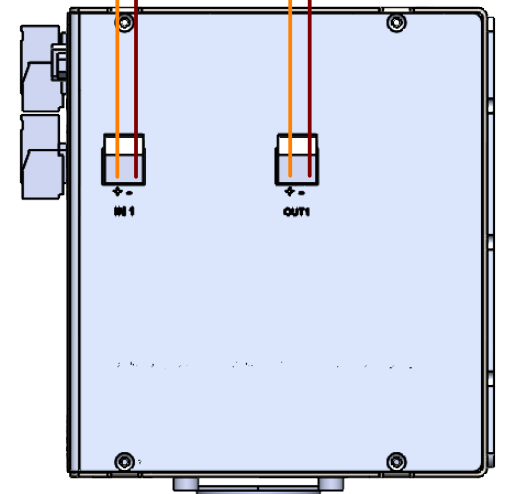
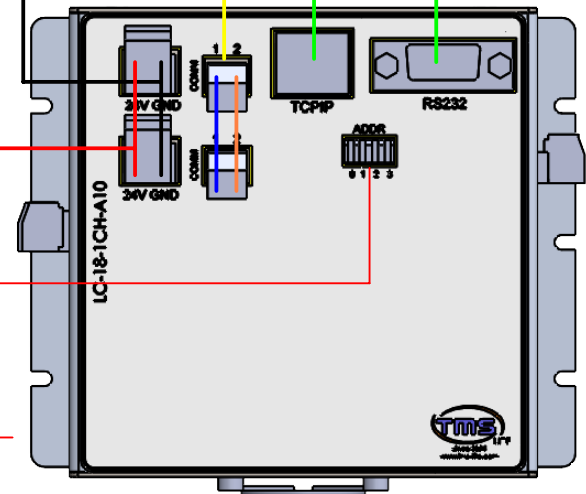

DESIGN BY	KANG	UNIT: MM
CHECK BY	KB TAN	SIZE A4
DATE	29/11/2024	REVISION: 01
MATERIAL	-	SCALE: 1:1
FINISHING	-	
QTY	-	

PRODUCT SERIES: LC-18 SERIES



TITLE	DRAWING LAYOUT	GEN. TOLERANCES
PART NO	-	X ±0.15
DWG NO	LC-18-1CH-A10	X.X ±0.1
		X.XX ±0.05
		SHEET 1 OF 1