

CONTROLLER DATASHEET



PART NUMBER: LC-18-OD-4CH-X2-24V

MECHANICAL PART

2D DRAWING

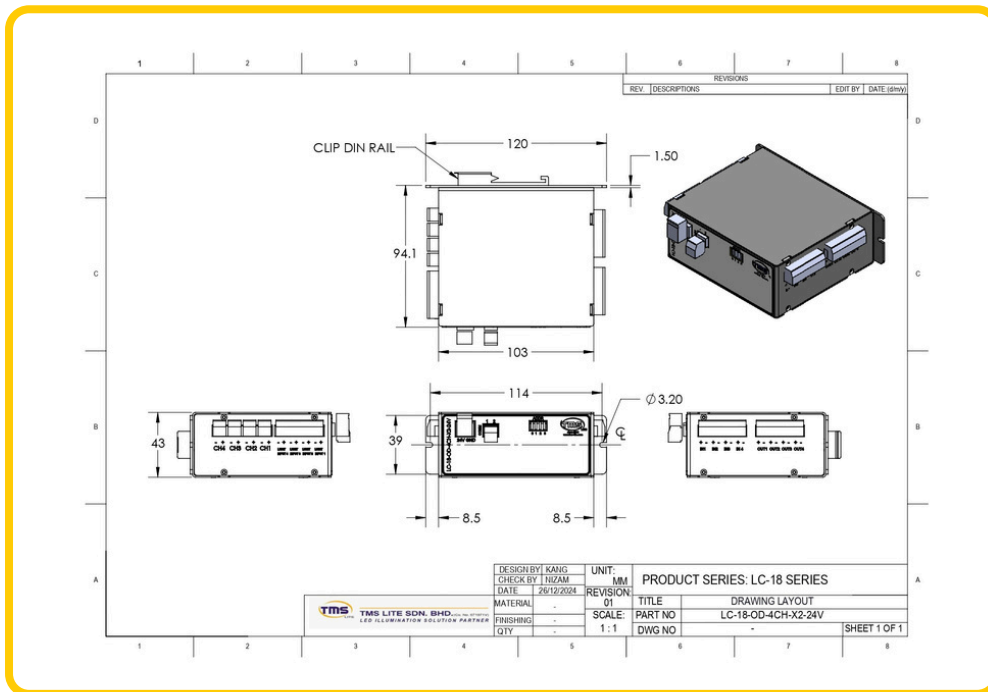

3D DRAWING

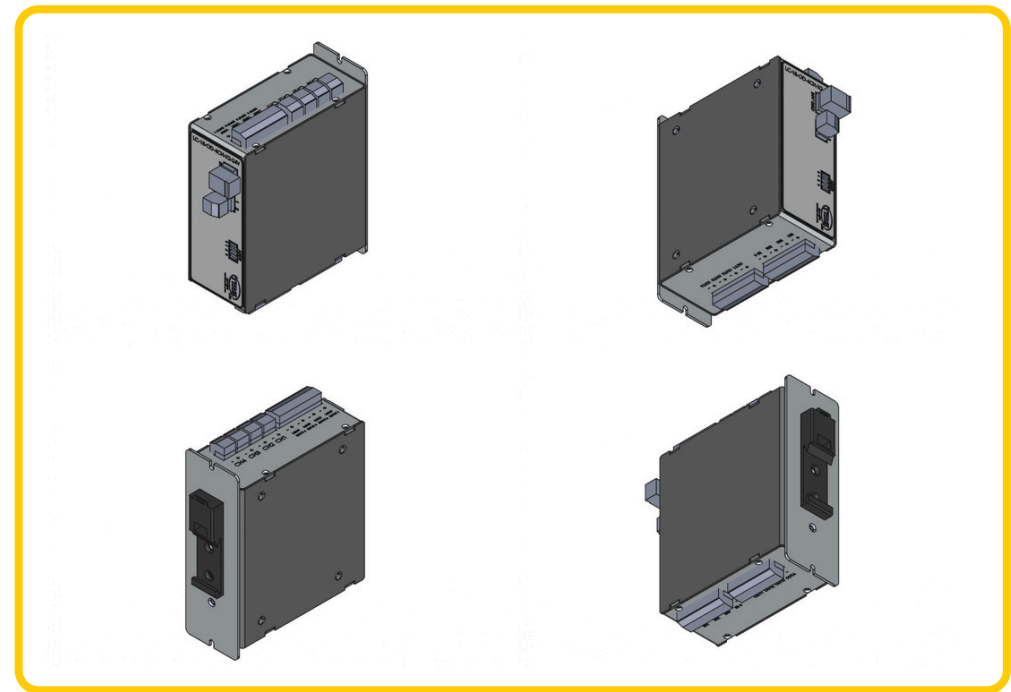

CONTROLLER DATASHEET



PART NUMBER: LC-18-OD-4CH-X2-24V

ELECTRICAL PART

SCHEMATIC DIAGRAM

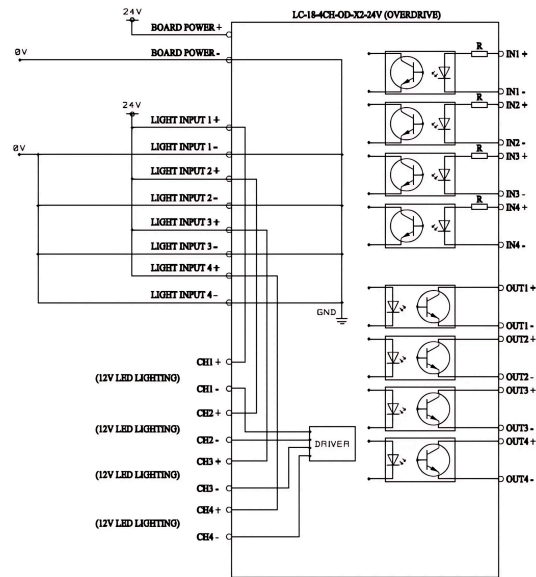

TIMING DIAGRAM

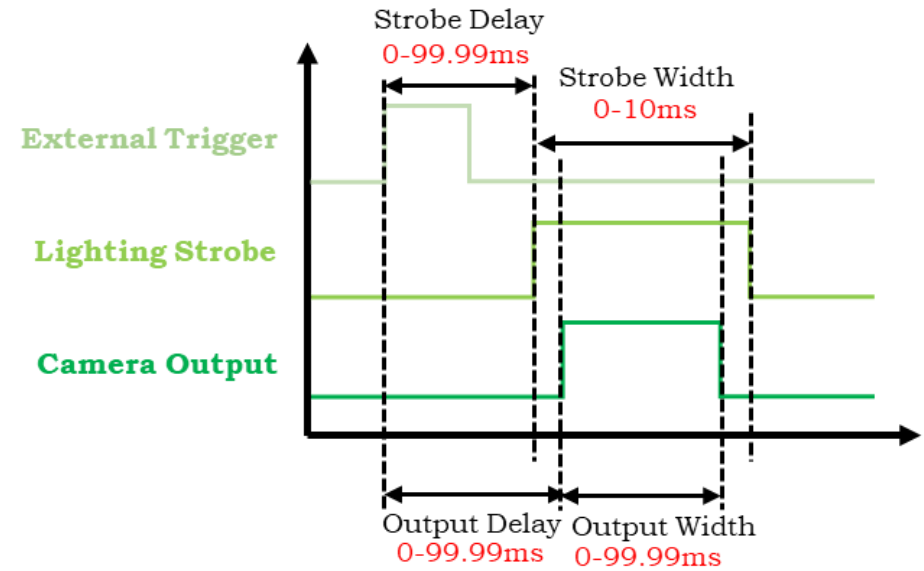

CONTROLLER DATASHEET



WIRING DIAGRAM

