



Specifications:

Type	Digital Controller
Series	LC-18 Series
Dimension	120 x 94.1 x 43 mm
Communication Type	To be connected with LC-18-M
Controller Supply Voltage	48VDC
Output Current	2A / Channel
Lighting (Input Voltage)	48V
Lighting (Output Voltage)	Based on lighting input voltage
Digital Input	4
Digital Output	4
No. of channel	4 Channels
Mode	Strobe
Strobe Width	0 - 10.00ms (0.01ms / step)
Trigger Delay	≤ 25μs

Part Number:

LC-18-OD-4CH-X2-48V

Product Naming Convention:

LC-18-OD-4CH-X2-48V

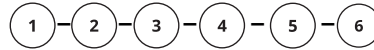

1. Light Controller
2. Series 18
3. Overdrive
4. 4 Channels
5. Lighting Output Current 2.0A (without Master Board)
6. Power Adapter Voltage: 24V

Application

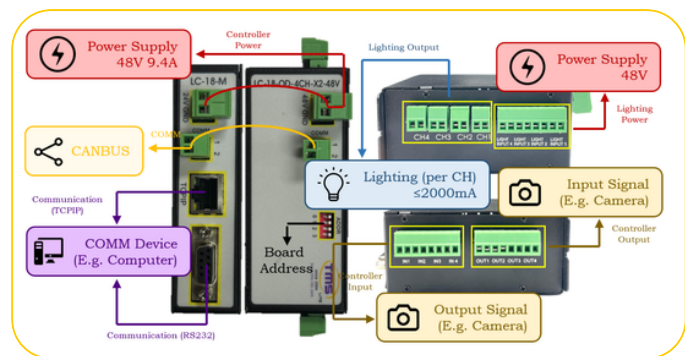

Features

- Intensity control for LED lighting in machine vision applications
- 4 channels with individual settings
- 1 mode of operation for diverse application support
- Need connect with LC-18-M

Advantages

- Programmability
- Able to control multiple lighting
- Software control
- Able to overdrive for 24v lighting
- Able to cascade via control board address

Benefits

- Compact size
- Fast respond in strobing
- Easy to install