

CONTROLLER DATASHEET

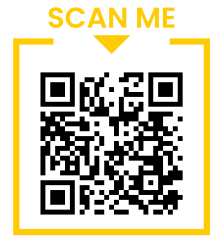

PART NUMBER: ST-1000-A1

MECHANICAL PART

2D DRAWING

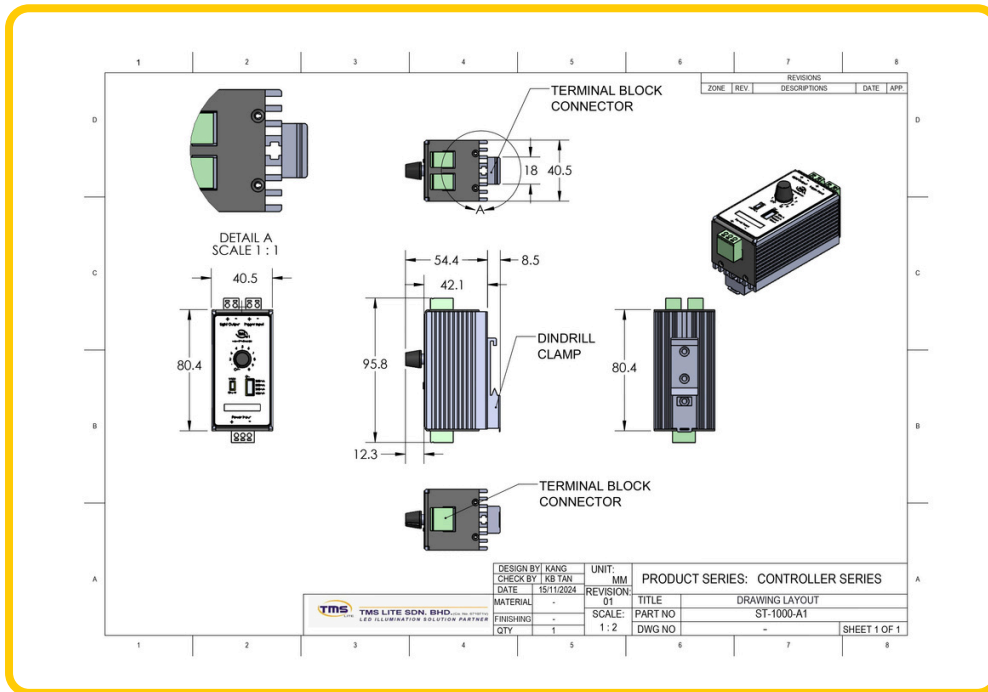

3D DRAWING

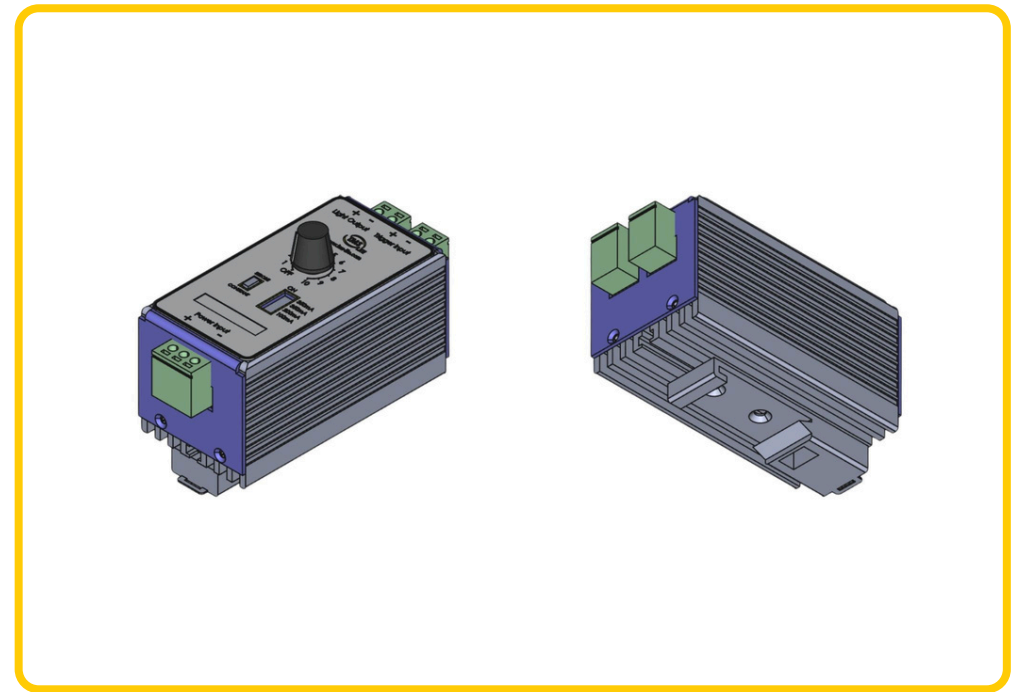

CONTROLLER DATASHEET

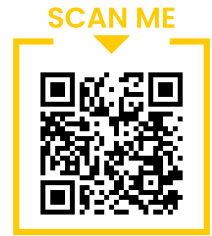

PART NUMBER: ST-1000-A1

ELECTRICAL PART

SCHEMATIC DIAGRAM

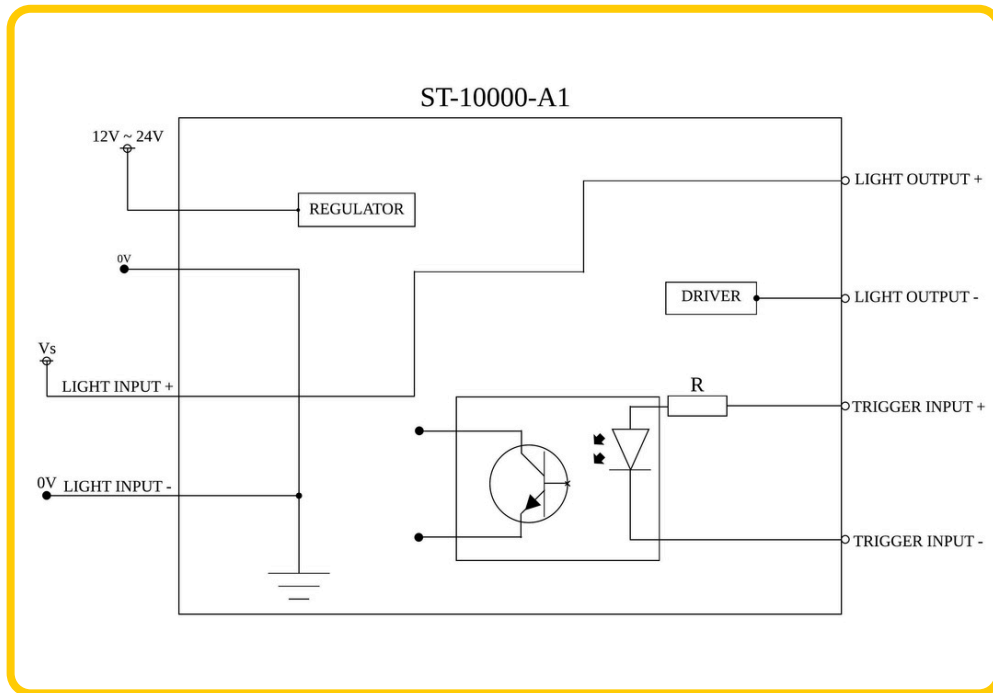

TIMING DIAGRAM

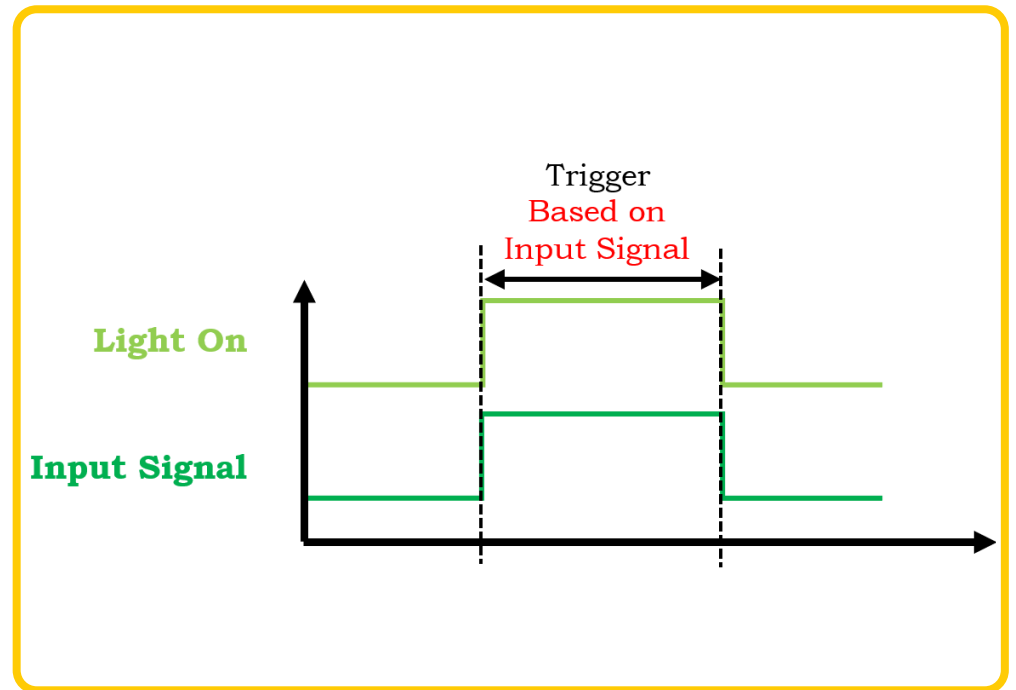

CONTROLLER DATASHEET

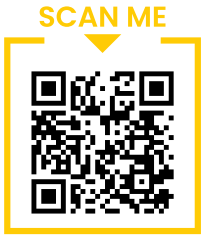

WIRING DIAGRAM

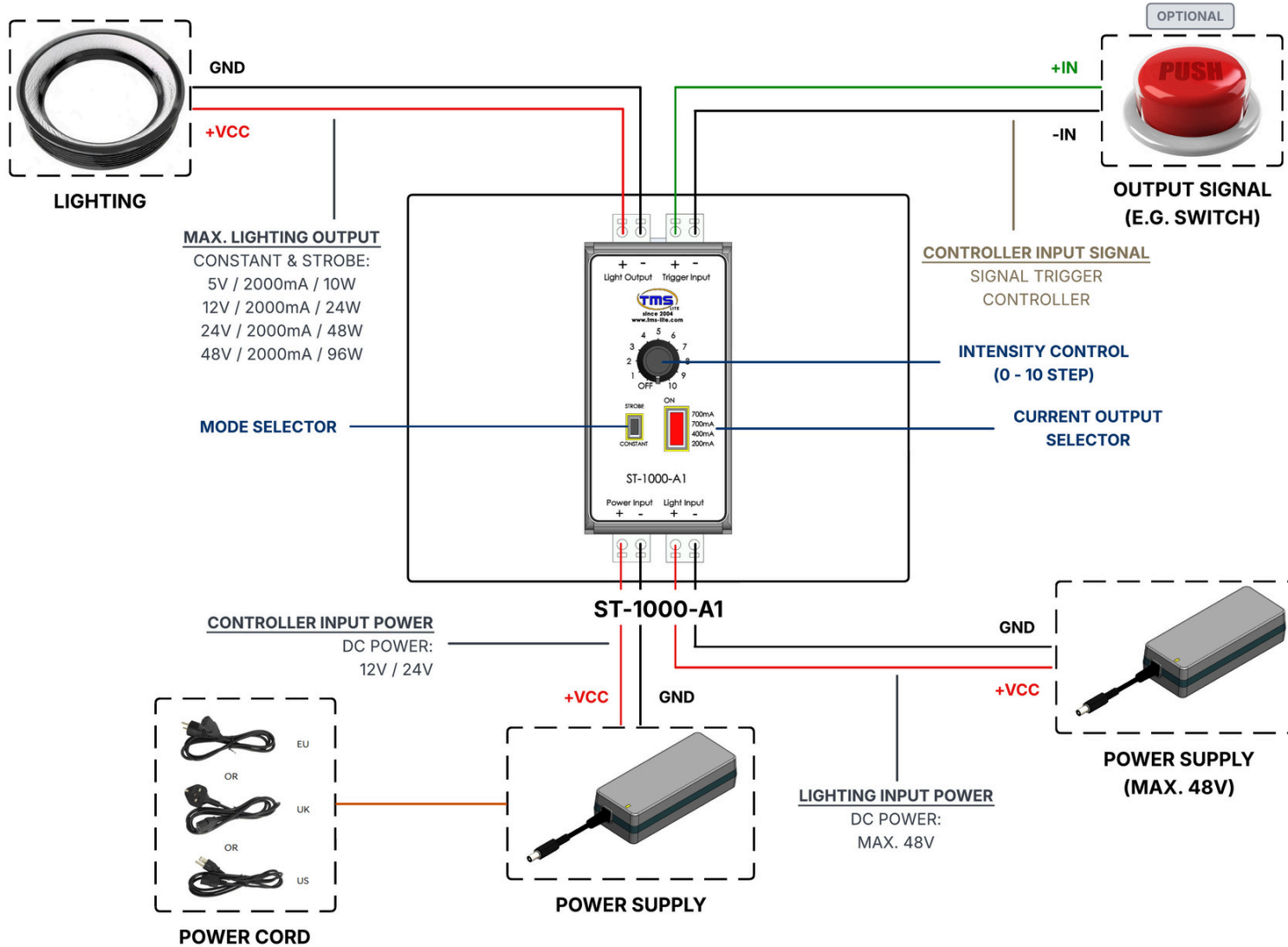

MAX. LIGHTING OUTPUT
CONSTANT & STROBE:
5V / 2000mA / 10W
12V / 2000mA / 24W
24V / 2000mA / 48W
48V / 2000mA / 96W

CONTROLLER INPUT SIGNAL
SIGNAL TRIGGER
CONTROLLER

INTENSITY CONTROL
(0 - 10 STEP)

**CURRENT OUTPUT
SELECTOR**

CONTROLLER INPUT POWER
DC POWER:
12V / 24V

LIGHTING INPUT POWER
DC POWER:
MAX. 48V

POWER CORD

POWER SUPPLY

POWER SUPPLY
(MAX. 48V)