

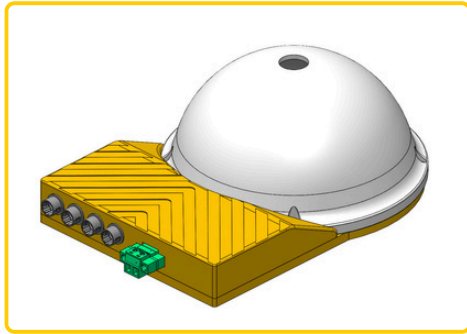

Scan or Click the QR code for more information



## Specifications

<b>Type</b>	Digital Controller
<b>Series</b>	Driver Series
<b>Dimension</b>	
<b>Communication Type</b>	RS232
<b>Controller Supply Voltage</b>	24VDC
<b>Output Current</b>	1A / Channel
<b>Lighting (Input &amp; Output Voltage)</b>	Based on controller supply voltage
<b>Digital Input &amp; Output</b>	1
<b>No. of channel</b>	6 Channels
<b>Mode</b>	Constant & Strobe
<b>Strobe Width</b>	0 - 9,999ms (1ms / step)
<b>Trigger Delay</b>	≈ 1ms

## Optional



**Custom Camera**

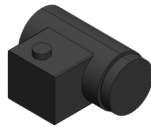

**Liquid Lens**



Scan or Click the QR code for liquid lens information

## Application

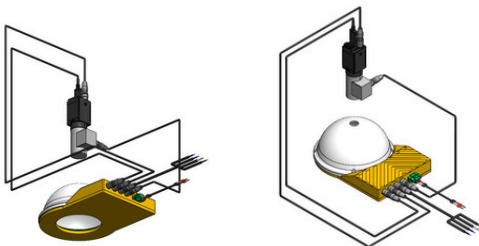

## Connector Pinout

### COMMUNICATION HIROSE 4PIN

BROWN	PIN 1	RXD
WHITE	PIN 2	TXD
BLUE	PIN 3	GND
BLACK	PIN 4	N/A

### CAMERA HIROSE 5PIN

BROWN	PIN 1	REF_V+
WHITE	PIN 2	OPTO_OUT
BLUE	PIN 3	OPTO_IN
BLACK	PIN 4	REF_GND
GRAY	PIN 5	GND

### EXTERNAL IO HIROSE 6PIN

BROWN	PIN 1	INI+
BLACK	PIN 2	INI-
GREEN	PIN 3	OUTI+
YELLOW	PIN 4	OUTI-
WHITE	PIN 5	N/A
ORANGE	PIN 6	N/A

### LIQUID LENS HIROSE 7PIN

RED	PIN 1	SV
BLACK	PIN 2	RX
GREEN	PIN 3	TX
YELLOW	PIN 4	GND
WHITE	PIN 5	GND
ORANGE	PIN 6	N/A
BLUE	PIN 7	N/A

## LED Wavelength

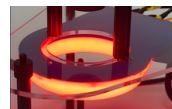
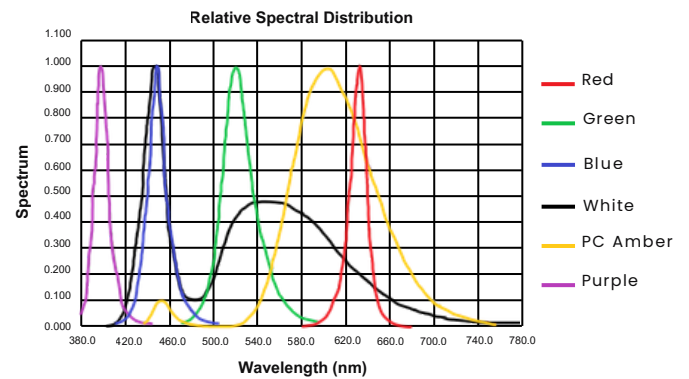

**Red**

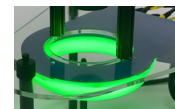

**Green**

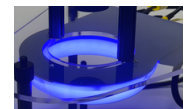

**Blue**

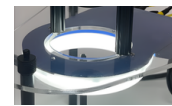

**White**



**Amber**

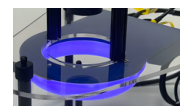

**Purple**

## Features

- 6 different wavelengths
- Built-in driver
- Dedicated connectors for direct connection to the camera and liquid lens
- Includes a dome cover for uniform, indirect lighting from all angles

## Advantages

- Suitable for reflective surface & color inspection
- Suitable for the inspection of round objects
- Lighting able to penetrate evenly on reflective surface
- Minimizes cabling requirements

## Benefits

- Saves time and reduces costs
- Improves efficiency
- Optimizes space and enables a clean, streamlined installation