

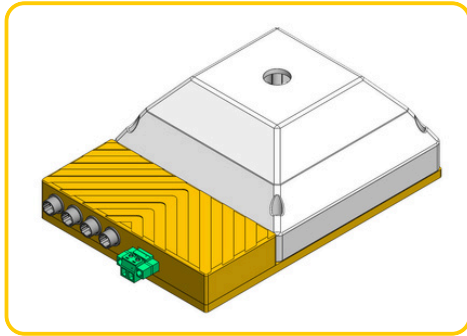

Scan or Click the QR code for more information



Specifications

Type	Digital Controller
Series	Driver Series
Dimension	TBA
Communication Type	RS232
Controller Supply Voltage	24VDC
Output Current	1A / Channel
Lighting (Input & Output Voltage)	Based on controller supply voltage
Digital Input & Output	1
No. of channel	8 Channels
Mode	Constant & Strobe
Strobe Width	0 - 9,999ms (1ms / step)
Trigger Delay	≈ 1ms

Optional



Custom Camera

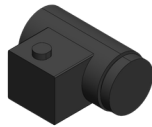

Liquid Lens



Scan or Click the QR code for liquid lens information

Application

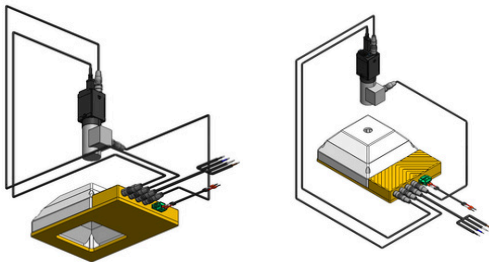

Connector Pinout

COMMUNICATION HIROSE 4PIN

BROWN	PIN 1	RXD
WHITE	PIN 2	TXD
BLUE	PIN 3	GND
BLACK	PIN 4	N/A

CAMERA HIROSE 5PIN

BROWN	PIN 1	REF_V+
WHITE	PIN 2	OPTO_OUT
BLUE	PIN 3	OPTO_IN
BLACK	PIN 4	REF_GND
GRAY	PIN 5	GND

EXTERNAL IO HIROSE 6PIN

BROWN	PIN 1	INI+
BLACK	PIN 2	INI-
GREEN	PIN 3	OUT+
YELLOW	PIN 4	OUT-
WHITE	PIN 5	N/A
ORANGE	PIN 6	N/A

LIQUID LENS HIROSE 7PIN

RED	PIN 1	SV
BLACK	PIN 2	RX
GREEN	PIN 3	TX
YELLOW	PIN 4	GND
WHITE	PIN 5	GND
ORANGE	PIN 6	N/A
BLUE	PIN 7	N/A

LED Wavelength

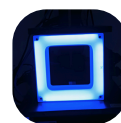
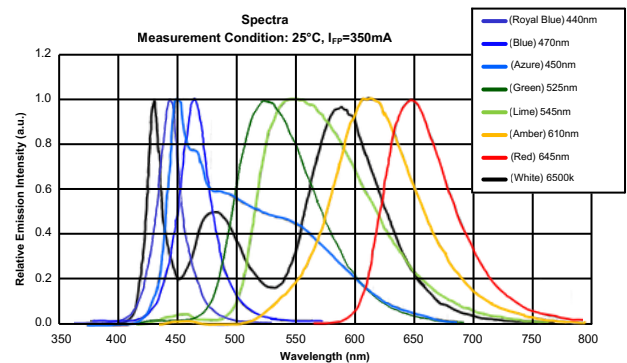

Royal Blue

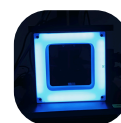

Blue

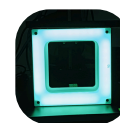

Azure



Green

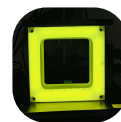

Lime

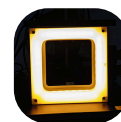

Amber

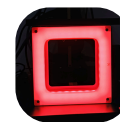

Red

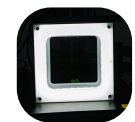

White

Features

- 8 different wavelengths
- Built-in driver
- Dedicated connectors for direct connection to the camera and liquid lens
- Includes a square dome cover for uniform, indirect lighting from all angles

Advantages

- Suitable for reflective surface & color inspection
- Suitable for inspection of square or rectangular object
- Provides even lighting on reflective surfaces
- Minimizes cabling requirements

Benefits

- Saves time and reduces costs
- Improves efficiency
- Optimizes space and enables a clean, streamlined installation