

1 2 3 4 5 6 7 8

REVISIONS			
REV.	DESCRIPTIONS	EDIT BY	DATE:(d/m/y)
01	NEW DRAWING LAYOUT	SL LEE	27/10/2015
-	-	-	dd/mm/yyyy

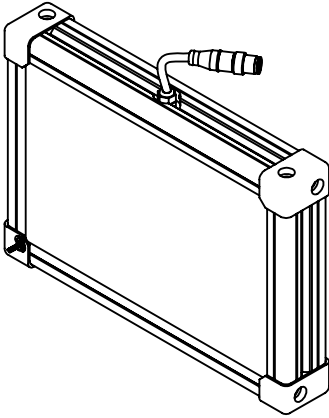
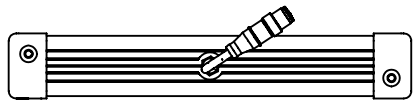

M12 CONNECTOR
70CM CABLE

EMITTING AREA

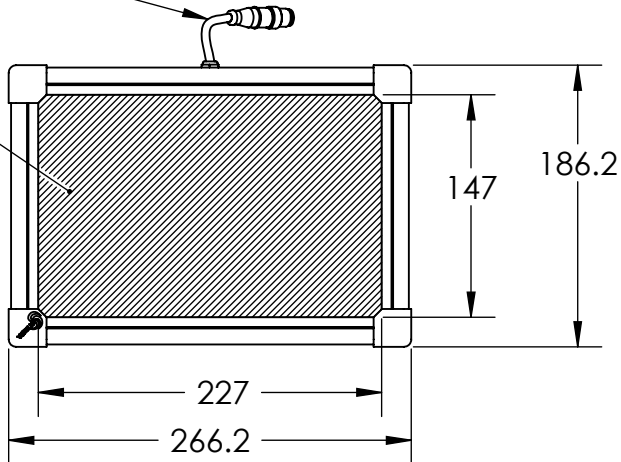

MALE

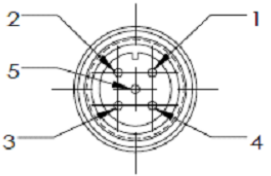

PIN 1	BROWN	24V
PIN 2	WHITE	-
PIN 3	BLUE	GND
PIN 4	BLACK	-
PIN 5	GRAY	-

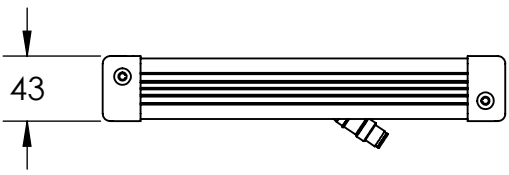

CUSTOMER APPROVED
& DATE



DESIGN BY	SL LEE	UNIT:	PRODUCT SERIES: HBBX SERIES	
CHECK BY	KB TAN	MM		
DATE	27/10/2015	REVISION:	TITLE	DRAWING LAYOUT
MATERIAL	-	01	PART NO	HBBX-00-160X240-X-X-24V
FINISHING	-	SCALE:	DWG NO	-
QTY	-	1 : 5	SHEET 1 OF 1	

1 2 3 4 5 6 7 8