

REVISIONS				
ZONE	REV.	DESCRIPTIONS	DATE	APP.

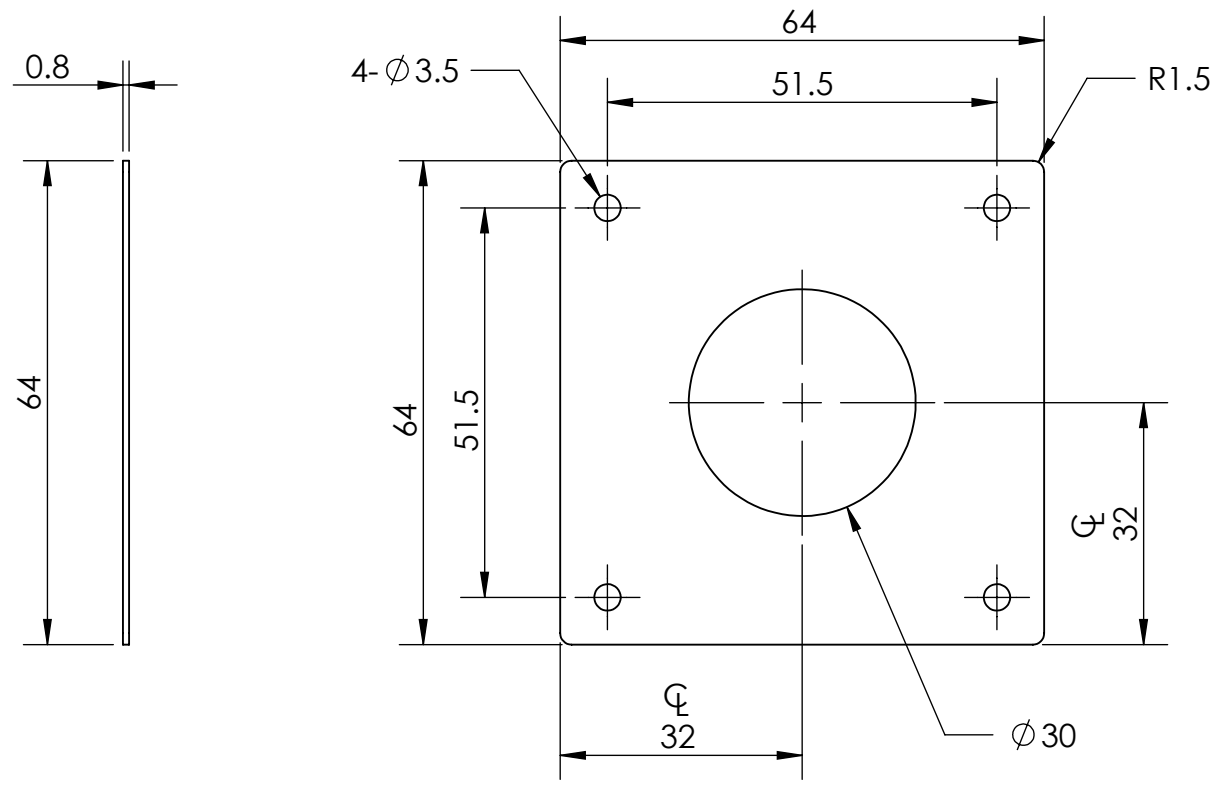

COLOR	WAVE LENGHT
RED:	660nm
GREEN:	525nm
BLUE:	470nm
WHITE:	--
IR 850:	850nm
IR 940:	940nm
UV:	380-385nm
RGB:	660nm/525nm/470nm



DESIGN BY	FASIAH	UNIT:	MM
CHECK BY	KB TAN	REVISION:	01
DATE	23/2/2018	SCALE:	1 : 1
MATERIAL	POLARIZER 0.8 MM		
FINISHING	-		
QTY	1		

<b>PRODUCT SERIES: LSQ SERIES</b>			
TITLE	POLARIZER	COLOUR:	- - -
PART NO	LSQ-00-060-3-X-24V	VOLTAGE:	- - -
DWG NO	LSQ-00-060-3-X-24V-03 (REV 01)	CURRENT:	- - -
		POWER:	- - -
			SHEET 3 OF 3