

REVISIONS

ZONE	REV.	DESCRIPTIONS	DATE	APP.
------	------	--------------	------	------

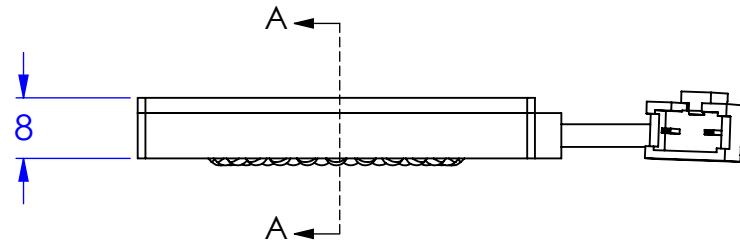
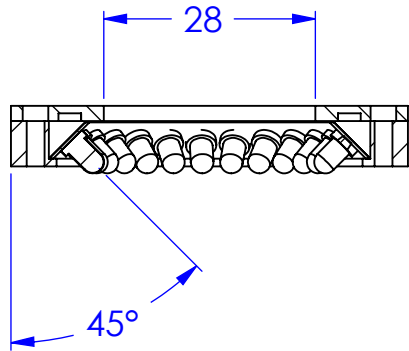
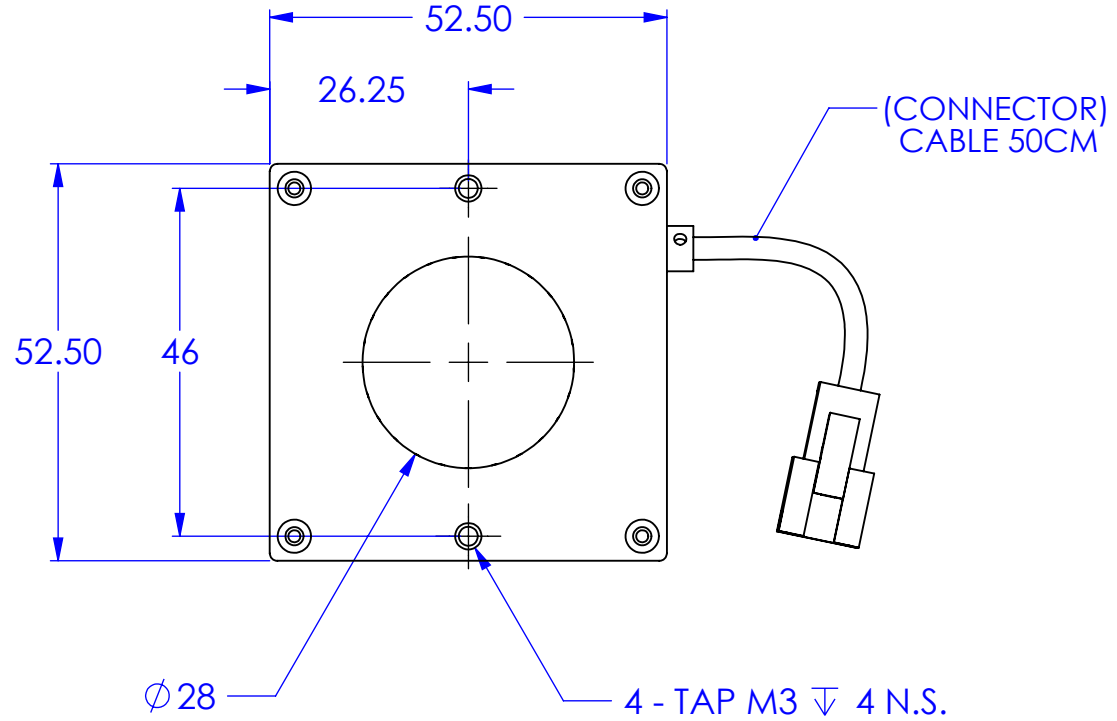
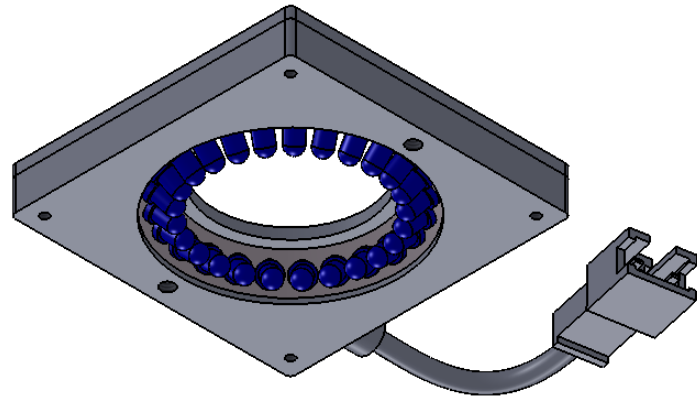

DESIGN BY	DS CHAN	UNIT:	PRODUCT SERIES: LSQ SERIES				
CHECK BY	DS CHAN	MM					
DATE	15/05/2014	REVISION:	TITLE	DRAWING LAYOUT	COLOUR:	-	-
MATERIAL	-	02	PART NO	LSQ-45-050-1-X-24V	VOLTAGE:	-	-
FINISHING	-	SCALE:	DWG NO	-	CURRENT:	-	-
QTY	-	1:1			POWER:	-	-
					SHEET 1 OF 1		